

User Manual

English

UCI portable hardness tester



dmq

QH5 U

Ultrasonic

www.demeq.com

QH5 U - User Manual

UCI portable hardness tester

P/N: QHDU 501 – ENG – Rev 01 – 2017

Index

Chapter 1	First steps	
1.1	Know the QH5 U	1
1.1.1	Front panel	1
1.1.2	Connectors	2
1.2	Install or replace batteries	3
1.3	Connecting the UCI probe	5
1.4	UCI probe components	5
1.5	Using the UCI probe	6
1.5.1	UCI probe configuration	6
1.5.2	Measuring: preloading and loading	8
1.6	The “Q” key	9
1.7	Display illumination and contrast	9
1.7.1	Display backlight illumination	9
1.7.2	Display contrast	10
1.7	Locking and unlocking the keypad	10
Chapter 2	Measuring with the QH5 U	
2.1	Numerical measuring screens (Normal)	12
2.1.1	Mode-1 screen (Datalogger)	12
2.1.2	Mode-2 screen (Material)	13
2.1.3	Mode-3 screen (Statistics)	13
2.2	Key functions in numerical measuring modes	14
2.3	Graphical measuring screen (Histogram)	16
2.4	Key functions in graphical measuring modes	17
2.5	Selecting material and hardness unit	17

Chapter 3	Menu system and editing	
3.1	Instructions on using the menu system	19
3.1.1	Text editor	20
3.2	Main menu	22
3.2.1	Change hardness unit	22
3.2.2	Alarm settings	23
3.2.3	Set histogram range	23
3.2.4	Select language	24
3.2.5	Unit information	24
3.3	General configuration options	25
3.3.1	Time and date	25
3.3.2	Time and date format	26
3.3.3	Keypad sensitivity	26
3.3.4	Auto-off time	27
3.3.5	Display display contrast	28
3.3.6	Beep activation	29
3.3.7	Introduction screen	29
3.3.8	Owner information	29
3.3.9	Lock configuration options	30
3.3.10	factory default settings	31
3.4	Measuring configuration (Hardness)	32
3.4.1	Select material	32
3.4.2	Creating user materials	33
3.4.3	The "Plus" key	37
3.4.4	Group (N) number	38
3.4.5	Indentation dwell time	38
3.4.6	Measuring filter	39
3.4.7	Measuring modes	40
3.4.8	Factory default settings	41

Chapter 4	Using the Datalogger	
4.1	Understanding how data is organized	42
4.2	Memory menu	43
4.3	Create a new file	43
4.4	Actions over single files	44
4.4.1	View data in a single file	45
4.4.2	The “Q” key in a grid	46
4.4.3	The “Q” key in a histogram	47
4.4.4	Rename file	47
4.4.5	Send data in file	48
4.4.6	View file size	48
4.5	Actions on all files	48
4.5.1	Send all files	48
4.5.2	Erase all files	49
4.6	Quick memory menu (Mem key)	50
4.7	Connecting to a PC with DataCenter	51
4.8	Datalogger configuration	52
4.8.1	Configure communications	52
4.8.2	Capture modes	53
4.8.3	Advanced configuration	54

Appendix

Tips on how to measure correctly	55
Measuring ranges and hardness units	55
Technical specifications	57
Additional information	59
Unit maintenance	59
QH5 U accessories	60
Error messages	61
Our website: www.demeq.com	62
Firmware and software updates	62
Technical support	62

Thank you choosing dmaq

And thank you for purchasing a QH5 U UCI portable hardness tester.

Company Statement

At Demeq we develop, manufacture and distribute software and quality control instruments offering innovation and solutions that come as a direct result of listening to your needs as a user. We apply some of the latest technology available in the industry to build instruments that are robust, precise and easy to operate.

We are convinced that our products would not be complete without permanent technical and after sales support. So in addition to quality products we offer:

- Quick answers to your inquiries.
- Unlimited access to technical information as well as application notes.
- Firmware and software upgrades at no charge.
- Attention to your inquiries and suggestions.

We hope that the QH5 U will meet and exceed your application needs.

General information

Models included in this manual

Information included in this manual applies to the QH5 U portable hardness tester.

Registered trademarks

dmq is a registered trademark of Demeq S.R.L and its affiliate companies.

Important notice

The information contained in this manual is intended to educate users on the operation of the QH5 U hardness testers. Failure to read and understand this manual can lead to measurement errors. Decisions based on measurements and or results that are erroneous can lead to property damage, personal injury or even death. Demeq S.R.L assumes no responsibility as a result of improper use of our instruments.

Applicable standards

ASTM A1038

User training

Correct use of a UCI hardness tester requires that you take all of the following into consideration:

- Select the UCI probe that is best suited for your application.
- Know the specific requirements for the test you will be conducting.
- Make sure that the person operating the unit has been trained on its use.

This manual provides all of the information needed to configure and operate the QH5 U portable hardness tester. However there are additional factors that can affect tests done with this instrument. Specific information on those factors is outside the scope of this manual. When in doubt you should always seek expert advice or refer to specific textbooks on portable hardness testing. Additional information can also be found on the internet and through local government agencies as well as in technical institutes.

Measuring Principle

The QH5 U operates on the UCI or Ultrasonic Contact Impedance method of hardness testing where just like in conventional methods such as Vickers, Brinell or Knoop, hardness values are obtained by applying constant force to an indenter which generates an indentation on the part being tested. But where as in conventional methods further optical evaluation is required, with the QH5 U readings are processed electronically and instant measurements are obtained in the most common hardness units.

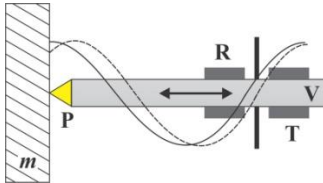

Figure 1: UCI probe

Figure 1 represents a UCI probe where the indenter **P** is normally a Vickers type synthetic diamond cemented to an oscillating rod **V** which is excited by a transmitting element **T** at a frequency that changes according to the depth of the indentation generated on part *m*. Frequency changes are detected by a receiver **R** and finally

the QH5 U converts those frequency changes into hardness units using a curve such as the one shown in Figure 2.

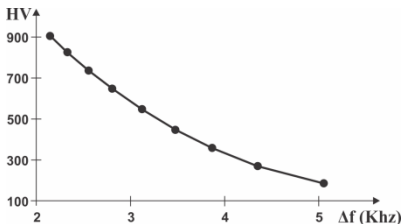

Figure 2: Relationship between hardness and frequency

Selecting the UCI probe

We offer 2 UCI probes with the QH5 U that differ in the test loads.

UCI probe part no. QHS010 with a 10N / 1Kgf load

This probe is ideal for surface hardness measurements as well as parts with low roughness and polished surfaces. Recommended for bearings, gear flanges, small die-stamp parts and moulds, etc.

UCI probe part no. QHS050 with a 50N / 5Kgf load

The 50N probe is used to measure hardness on rougher surfaces, cemented parts, pipes, welds, gears, crankshafts and much more.

Test piece requirements

Minimum test piece conditions in order to obtain correct measurements with the QH5 U for each type of probe are:

	UCI probe 10N / 1kgf	UCI probe 50N / 5kgf
Roughness (Ra)	1,5 μm	2,5 μm
Curvature radio	>5 mm	
Weight	>0,1 Kg	
Thickness	<1 mm	



Important

Always clean the surface of the test piece being measured to make sure it is free from oil and grease.

To obtain better results always use the UCI probe perpendicular to the test piece surface.

Important: Safety Information

The QH5 U portable hardness tester is for industrial use only and cannot be used in medical applications.

The QH5 operates with two alkaline "AA" size batteries. Use only top brand name batteries.

Disposal of your QH5 or any of its components must be done in compliance with your local applicable regulations.

About our Software

Because software is complex in nature and errors may eventually appear you should check that functions required for your application are working correctly.

Warranty

Demeq provides a limited 5 (five) year warranty on electronic units and 6 (six) months on probes from the date of purchase. Please remember to register your unit at:

<http://www.demeq.com/Contact.html>

Every instrument undergoes thorough testing during manufacturing as well as before shipping. In the event that warranty service becomes necessary, Demeq or your local distributor will make a reasonable effort to replace your defective unit with another new or used unit while your instrument undergoes warranty repair. In all circumstances shipping charges are the end users responsibility.

1 First steps

1.1 Know the QH5 U

1.1.1 Front panel

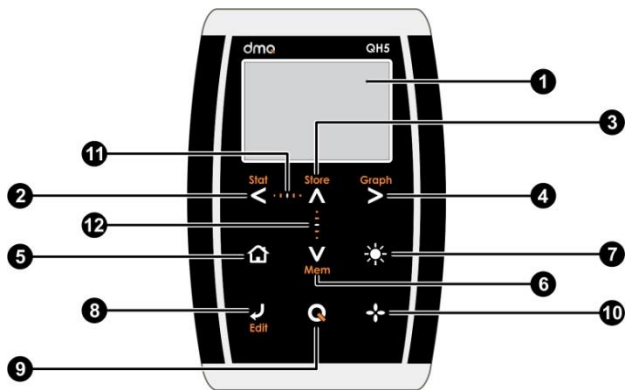

Figure 1.1: Front of the unit

1. Graphic LCD display with LED backlight illumination
2. Move Left key / View partial statistics (Stat)
3. Move Up key / Manually store a value (Store)
4. Move Right key / Switch to graphical measure mode screen (Graph)
5. Menu key / Enter and exit measure screen / Exit and return to menus (Home)

6. Move Down key / Quick access to memory menu screen options (Mem)
7. Change backlight illumination key (On, Off, Auto)
8. Enter key / Edit values on the measure screen (Edit)
9. The **Q** key: Power On and Shutdown (touch and hold for 2 seconds) / Make quick and short touches to activate special functions
10. The **+** key: Direct measure screen access from any menu screens / User selectable functions
11. Horizontal scrolling center point (lock and unlock keypad on measuring screen)
12. Vertical scrolling center point (adjust LCD contrast)

1.1.2 Connectors

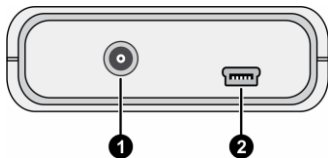

Figure 1.2: Unit connectors

1. UCI probe connector type Lemo 00
2. USB mini connector to connect to PC using a USB cable

1.2 Install or replace batteries

The QH5 U is powered by 2 (two) "AA" batteries that go in the battery compartment located in back of the unit. To open the battery compartment slide the cover as shown in Figure 1.3-1 and gently push the extraction ribbon upward and towards the right to release the batteries (Figure 1.3-2).

When you install new batteries, first insert the positive end of each battery so that it coincides with the positive pole inside the battery compartment as you can see in Figure 1.4-1.

Always leave the extraction ribbon underneath the batteries.

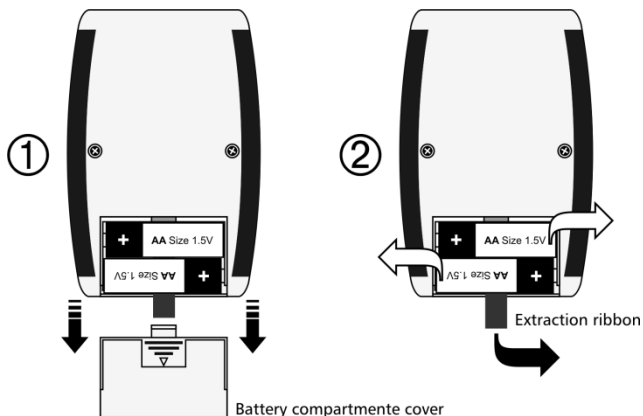

Figure 1.3: Battery compartment / battery removal

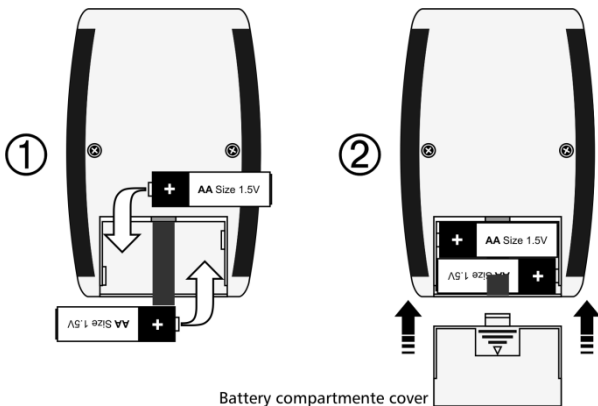

Figure 1.4: Replace / Insert batteries



Important

Do not remove batteries while the unit is turned on as this may affect the Datalogger (See Appendix: "Additional information, Error Messages")



Notes

Always use new alkaline top brand batteries for extended battery life, rechargeable NiMH batteries can be used but will result in less time of operation.

Do not mix new and old batteries. Always replace both batteries.

1.3 Connecting the UCI probe

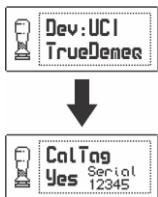

When the UCI probe is connected to the QH5 U a message is displayed indicating that the probe has been recognized. At this time do not try to measure as the unit will briefly auto-calibrate and in order for the unit calibration to proceed normally the UCI probe needs to be “left alone”.

Figure 1.5: Message indicating probe has been connected

1.4 UCI probe components

This section briefly explains all of the basic UCI probe components and their intended use.

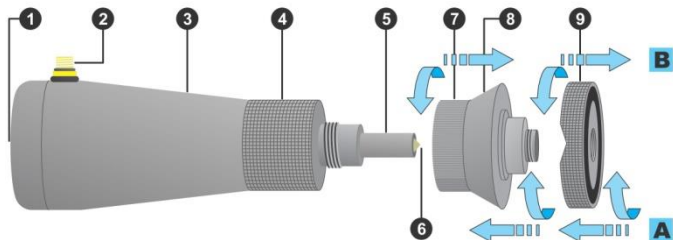

Figure 1.6: UCI probe components

1. Area where force is applied
2. Cable connector for cable that goes to the QH5 U
3. UCI probe body

4. Probe holding area (knurled)
5. Bottom end of the probe
6. Vickers indenter (synthetic diamond)
7. Holding accessory
8. Holding area for accessory
9. Adapting ring with 2 sides (flat and "V" cut)

The holding accessory and the adapter are threaded to the UCI probe body (accessory 7 is threaded to the probe and the adapting ring 9 is threaded to accessory 7). In Figure 3 threading directions are shown [A] to mount and [B] to remove.

1.5 Using the UCI probe

1.5.1 UCI probe configuration

Configure the UCI probe according to the surface of the part being tested. Choose to use one side of the ring or you can remove the ring all together.

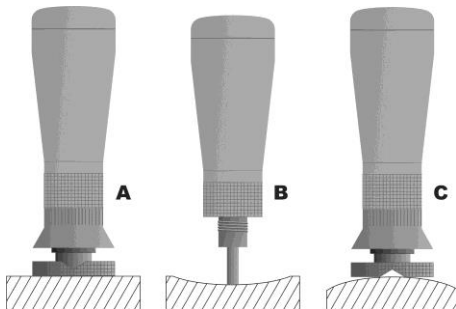
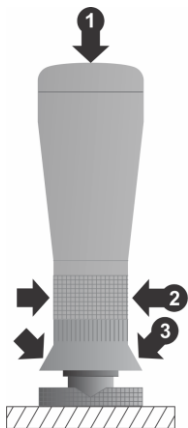

Figure 1.7: UCI probe configurations

Figure 1.7-A shows the UCI probe with the flat side of the support ring to measure on flat surfaces. In Figure 1.7-B the ring has been removed to measure over a concave surfaces (also used to measure in hard to reach areas, weld joints, etc). Figure 1.7-C shows the probe with the “V” side of the ring which is used to measure convex surfaces.



When you are ready to measure force must be applied on the UCI probe that has been ergonomically designed for comfort of use and ease of operation. The 3 points in Figure 5 show the positions to better hold and use the probe; point 1 (top of the probe) is a large and “soft” area where you should place the palm of your hand to gently push down. Point 2 lets you hold the probe so it doesn’t slide off your fingers or away from the test piece while point 3 allows you to hold and push down using fingers from both hands. Using the UCI probe with one hand only is also possible even though not recommended.

Figure 1.8: How to apply force

For best results use the support ring in order to maintain the probe vertical and stable when force is applied. If you need to remove the ring due to the geometry of the part being tested we suggest that you use both hands to hold the probe.

1.5.2 Measuring: preloading and loading

For precise and repetitive measurements force must always be applied in 3 simple steps as seen in Figure 1.9

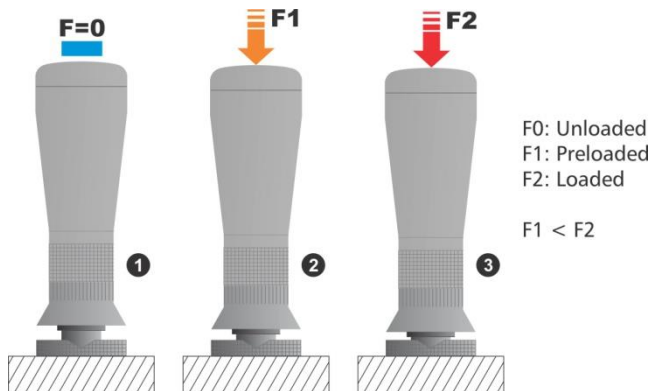

Figure 1.9: Preloading and loading the probe

From the measuring screen first set the probe on a test point without applying force 1. Then apply a preload force that will take the indenter “half way” into the test piece 2.







Figure 1.10: Instructions in measuring screen

At this point the unit will display 3 messages asking you to; 1 apply force on the probe, 2 to “maintain and wait...” until a hardness

reading is obtained and a final message **3** asking you to lift the probe. Repeat these simple steps for every measurement.

1.6 The "Q" key

The  key has three functions:

1. When the unit is off, touch  for 2 seconds to power on the unit.
2. When the unit is on, touch  for 2 seconds to shutdown the unit.
3. With the unit on, making short touches to the  will activate special functions described in each chapter of this manual.

1.7 Display backlight illumination and contrast

Backlight illumination and contrast options can be changed from any screen in the unit.

1.7.1. Display backlight illumination

Touch  to change the backlight illumination.

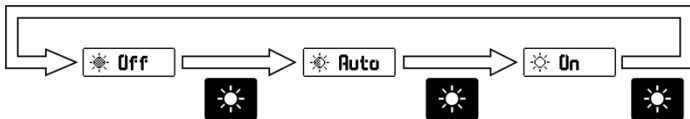
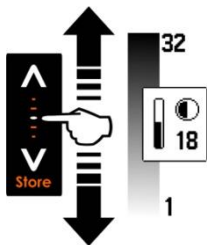

Figure 1.11: Backlight illumination options

1.7.2. Display contrast



The contrast on the QH5 U is digital. Touch the white dot located in the center of the vertical scrolling bar between the **▲** - **▼** keys and a contrast window will open. Move your finger towards the top and or bottom of the dotted line to adjust the contrast on your display.

Figure 1.12: Digital LCD contrast adjustment

1.7 Locking and unlocking the keypad

To lock the keypad place your finger on the white dot located in the center of the horizontal scrolling bar between the **<** - **▲** keys. Move your finger to the right following the dotted line and a window on the unit display will open with the message **Lock** (Figure 1.13). Continue moving your finger in the same direction until you enter blocked mode. The window on the display will close and the blocked keypad indicator will show on the top right of the unit screen.

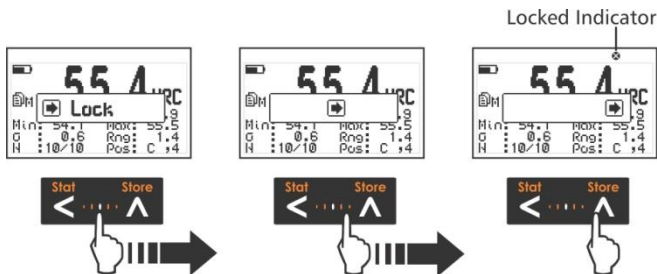

Figure 1.13: Locking the keypad

Sliding the finger to the left will unlock the keypad.

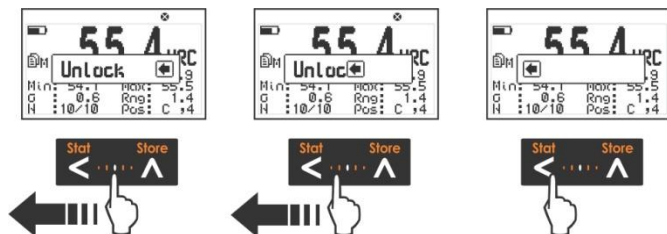



Figure 1.14: Unlocking the keypad



Important

The keypad can only be locked and unlocked in the measuring screens.

2 Measuring with the QH5 U

There are three modes in which the QH5 U can display measurements and information. Use the  key to switch modes as described in the following sections.

2.1 Numerical measuring screens (Normal)

2.1.1 Mode-1 screen (Datalogger)

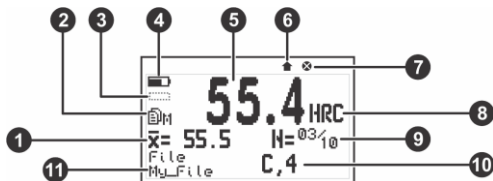

Figure 2.1: Mode-1 screen

1. Average hardness in the selected unit
2. Datalogger mode indicator; X: Off - M: Manual - A: Auto
3. + (plus) or – (minus) as it relates to the nominal value in differential mode (Page 40)
4. Battery level indicator
5. Hardness value in the selected hardness unit
6. Icon indicating that a value has been stored
7. Blocked keypad icon indicator (Page 10)
8. User selected hardness unit (Page 22)
9. Number of (N) values for real time statistics (Page 38)
10. Position of the last stored value (Column, Row)

- Open file name where values are being stored (*Page 43*)

2.1.2 Mode-2 screen (Material)

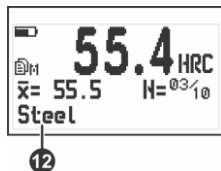

Figure 2.2: Measuring screen mode-2

- User select material

2.1.3 Mode-3 screen (Statistics)

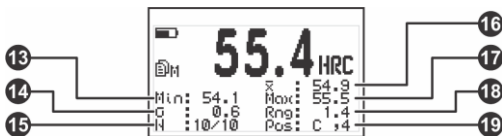

Figure 2.3: Measuring screen mode-3

- Minimum hardness value within the group
- Average deviation within the group
- Number of (N) values for real time statistics (*Page 38*)
- Group average
- Maximum hardness within group

18. Range within group
19. Location of the last stored value within the open file

2.2 Key functions in numerical measuring modes

Keys in all three numerical measure screen modes have the following functions:









- : Touch to generate real time statistics based on the number of (N) stored values at the time this function is activated.
- : Touch to manually store the measurement in the memory.
- : Touch to switch to the real time graphic histogram mode.
- : Touch to exit the measure screen and enter the main menu.
- : Touch to view quick memory access options.
- : Touch to access the select / edit mode. 2 flashing arrows will appear over the fields of material and hardness unit.

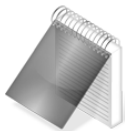

Figure 2.4: Mode-2 screen select / edit

- Touch  to select material.

- To select hardness unit touch .

Always use the   keys to edit the values in any given field and touch  to save.



Notes

The material can only be changed in the numerical measure screen in mode-2 (*Page 13*).

When the hardness unit is changed statistics, graphics and the actual hardness value on screen are set to zero.



: Short touches allow you to switch between the three measure screen modes. Touch for 2 or more seconds to shutdown the unit.



: Changes the backlight illumination.



: Enters the direct access function established by the user.



: Set display contrast.



: Lock and unlock keypad.

2.3 Graphical measuring screen (Histogram)

The QH5 U allows you to view graphic representations of measured values in real time and in two different modes.



Figure 2.5: Graphical measuring screens (mode-1 and mode-2)

1. Maximum hardness value within group
2. Minimum hardness value within group
3. Average within group
4. Hardness value in the selected hardness unit
5. Battery level indicator
6. High alarm HRC indicator (*Page 23*)
7. Reference line of average value within group
8. Low alarm indicator (*Page 23*)
9. Reference line for the hardness unit
10. Histogram bars represent single values within group
11. Average deviation within group
12. Range within group

2.4 Key functions in graphical measuring modes



Key functions in both graphical measuring modes are the same as in the numerical measuring modes (*Page 14*) except for the following keys:

 : Switch to the numerical measuring screen

 : Access the select / edit mode. Touch this key and a flashing arrow will appear over the hardness unit field.

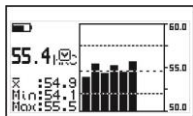
- To select hardness unit touch 



Use the   to edit and to save the change in the hardness unit touch .

 Change unit



Figure 2.6: Graphics screen on select-edit mode

2.5 Selecting material and hardness unit





The QH5 U measures steel with no need for calibration and 8 user materials can be created using calibration test blocks or samples of known material, hardness value and hardness unit.

Available hardness units depend on the selected material.

With the QH5 U there are 2 ways to change the material being tested:

- On the numerical screen in mode-2 only (Page 13) touch  to enter the select / edit mode and touch  to select the material. Edit using the cursor keys and touch  to save.
- From the main menu under Materials (Page 33).

The QH5 U offers three ways to change hardness unit:

- On the numerical measure screen touch  to enter the select / edit mode and touch  to select unit. Edit using the cursor keys and touch  to save.
- Touching the  as long it was set to Unit in the direct access options that can be set for this key (Page 38)
- From the main menu under Unit (Page 22)

For detailed information on the combination of materials, hardness units and hardness ranges that can effectively be measured, please refer to the tables in the Appendix "Tips on how to measure correctly" (Page 56)

3 Menu system and editing

3.1 Instructions on using the menu system

The instructions explained in this chapter apply to all of the menus in the unit.

To scroll QH5 menu options use the **▲** **▼** cursor keys. When you reach the end of the menu and move to the next menu option it becomes circular as shown herein.

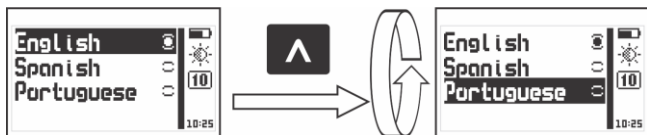

Figure 3.1: Example of how a circular menu works

To select a menu option touch **↩** and to exit and return to the previous menu touch **🏠**.

To go to the measuring screen touch **🏠** from the main menu, or touch **+** from any other menu in the unit.

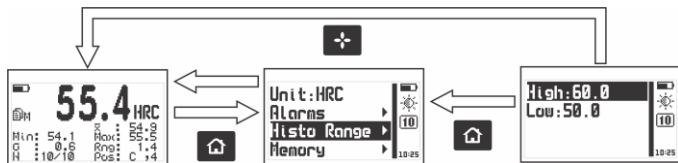

Figure 3.2: Going to the measuring screen

3.1.1 Text editor

The text editor is used to input, modify and delete; letters, numbers and symbols.



Figure 3.3: Alphanumeric editor screens

1. Selected key
2. Cursor
3. Text to be edited
4. Virtual keyboard

Use the cursor keys on the unit to scroll the virtual keyboard until you find the character that you want to use and touch  to select.

Touch the  key to move to the upper case virtual keyboard and to the numbers and symbols keyboard as seen on figure 3.3.

There are 4 keys that are common to all virtual keyboard screens:

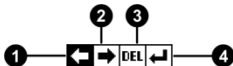

Figure 3.4: Common virtual keyboard keys

1. Move cursor to the left

2. Move cursor to the right
3. Delete carácter on which cursor is on
4. Enter and exit

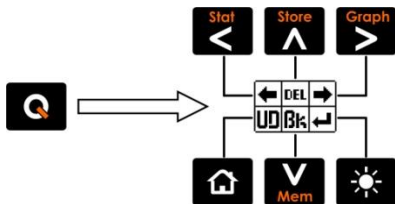



Figure 3.5: Quick access keys for the virtual keyboard editor

Touch the  key to open the direct access keyboard to the most commonly used virtual keyboard keys. Each virtual key corresponds to a key on the front panel of the unit as follows:



Stat: Move the cursor to the left



Store: Erase the character on which the cursor sits



Graph: Move the cursor to the right



Home: Undo



Mem: Erase the character to the left of the cursor



Sun: Enter and exit

To close the direct access keyboard and continue using the virtual keyboard touch .

3.2 Main menu

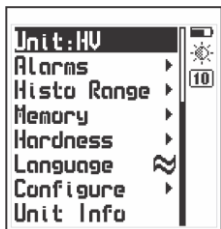



The main menu is the first list of options you will see when you exit the measure screen and it includes the most important settings. Touch  from the measuring screen to access this menu.

Figure 3.6: Main menu

Note: "Memory", "Configure" and "Hardness" are explained in detail in Chapters 4, 3.3 and 3.4 of this manual.

3.2.1 Change hardness unit

Unit

Touch  on **Unit** in the main menu to open the list of available hardness units.

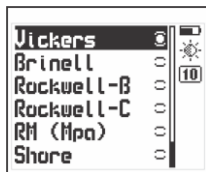

Use the   keys to scroll the menu.

Touch  to select the hardness unit.



Touch  to save and exit this menu.

Figure 3.7: Hardness unit menu (steel only)

3.2.2 *Alarm settings*

Alarms

The QH5 U has high and low alarm conditions that alert the operator when the measurement is greater than the value set for the high alarm or when the measurement falls below the low alarm value.

Touch  on **Alarms** to open the alarm menu options.

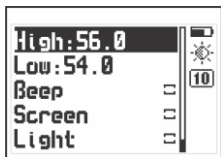

Touch  on **High** or **Low** to open the numbers editor where you can set alarm values using the cursor keys.

Touch  to save the alarm value that you entered and to return to the previous menu.

Figure 3.8: Alarm menu options

Alarm types that you can choose include:

Beep: Audible intermittent alarm type.

Screen: Visible alarm that causes measurements to be displayed in dotted instead of regular numbers.

Light: Visible alarm that activates the display backlight illumination causing it to flash.

3.2.3 *Set histogram range*

Histo Range

Here you can set high and low values (hardness range) that will be represented on the vertical axis of the histogram.

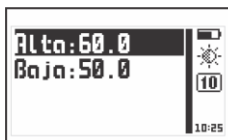

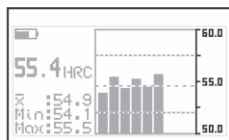

Set graphic range menu



Range view in graphic mode

Figure 3.9: Set histogram range values

Touch  on **Histo Range** to open the histogram menu.

Touch  on **High** or **Low** to open the numbers editor where you can set values using the cursor keys and touch  to save the new value and return to the previous menu.

3.2.4 *Select language*

Language

Touch  on **language** (identified with a flag) to view available language options.



Use the cursor keys to navigate available language options and touch  to select.

Touch  to save and exit this menu.



Figure 3.10: Language menu options

3.2.5 *Unit information*

Unit Info

Select **Unit Info** to view information including owner data as well as

the software version that your unit is running.

To switch between unit information screens touch the   keys. To return to the main menu touch .

3.3 General Configuration options Configure

Touch  on the **Configure** option to open the general configuration options menu.

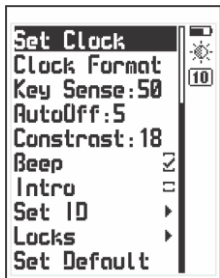

Use the   keys to scroll the menu.

Touch  to select any of the menu options.

Touch  to exit and to return to the previous menu.

Figure 3.11: General configuration options menu

3.3.1 Set time and date Configure » Set Clock



Choose **Set Clock** to open the time editor and use the cursor keys to set the time. Touch  to save and to enter the date editor screen. After you change the date touch  to save and exit.

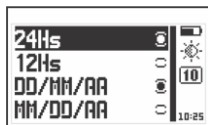

Figure 3.12: Time and date edit screens

3.3.2 *Set time and date format*

Configure » Clock Format

Choose **Clock Format** to open the menu that allows you to set the time format (12Hs or 24Hs) and the date format (D/M/Y – M/D/Y).









Touch  on the option you wish to select and touch  to save and exit.

Figure 3.13: Date and time format menu options

3.3.3 *Set keypad sensitivity*

Configure » Key Sens

This option allows you to set the keypad sensitivity. The higher the number, the more sensitive the keypad becomes.

Touch  on **Key Sens.** and use the  -  keys to change the keypad sensitivity. Touch  to save and the keypad will already be working with the new sensitivity level.

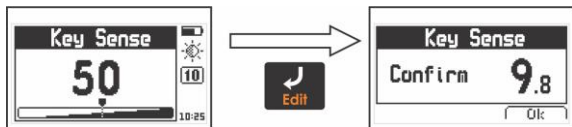

Figure 3.14: Key sensitivity setting and confirmation screens

To confirm the change in sensitivity touch . If you touch any other key or the on-screen counter reaches 0.0, the sensitivity will return to its previous setting. The factory default setting is 50. Under special conditions we suggest that the sensitivity level be changed.

Tips

If the unit will operated using security gloves we recommend that the sensitivity level be raised.

To make the keypad “harder” simply lower the sensitivity level.

In applications where the front of the unit may be exposed to water and or vapors the sensitivity should be lowered.

3.3.4 Set auto-off time Configure » AutoOff

The unit will shutdown automatically if no key is touched or no measurement is made after a time set by you.

Touch on **AutoOff** to set the time before the unit automatically shuts down.



Touch the **▲** **▼** keys to set the time and touch **↩** to save and exit.

Touch **🏠** to exit without changes.

Figure 3.15: AutoOff time setting screen

3.3.5 *Adjust display contrast*

Configure » Contrast

Contrast settings allow you to turn your screen lighter or darker where 1 is the lightest and 32 is the darkest.

Touch **↩** on **Contrast** and use the **▲** **▼** keys to change the contrast on your screen.

Touch **↩** to save or touch **🏠** to exit without making changes.

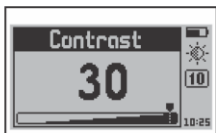
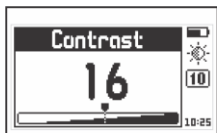

Figure 3.16: Screen contrast settings



Tips

Contrast on LCD screens can change with temperature. Use the contrast option to compensate for temperature these changes and maintain optimal viewing conditions.

3.3.6 *Beep Activation*

Configure » Beep

Beep refers to the sounds that the unit makes when keys are touched and when the audible alarm is active.

Touch  to enable or disable the beep option.

3.3.7 *Introduction Screen*

Configure » Intro



The introduction screen is the first screen that you see after the unit is turned on and includes owner information such as name, telephone number and e-mail.

Touch  to enable or disable this option.

3.3.8 *Owner Information*

Configure » Set ID

This option allows you to enter owner information (the info that would appear on the introduction screen).

Touch  on **Set ID**, enter the password (the factory default password is 12345) and touch  to access user info menu options.

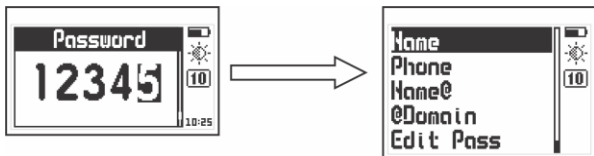

Figure 3.17: Enter password to access the user info menu

The user information that can be changed includes the following:

Name: Set or change the owner name.

Phone: Set or change the telephone number.

Name@: Set or change the e-mail (before the @).

@Domain: Set or change the domain for the e-mail (after the @).

Edit Pass: Allows you to change the password needed to access this menu.



Notes

To set or change text see page 20.

When showing user information, the e-mail address is displayed as "Name@Domain".



Important



The factory default password is 12345. You can change this password after adding your user information.

3.3.9 *Lock configurations*

Configure » Locks

Certain configuration options on your QH5 U unit can be locked in order to avoid unwanted changes. Use of the locking options allows a supervisor to optimize unit configuration settings required for a specific test and then pass the unit on to an operator for him or her to

conduct the actual measurements knowing that the unit has been properly configured and that settings cannot be changed.

Touch  on **Locks**, enter your password and then touch  again to view the configuration options that can be locked.

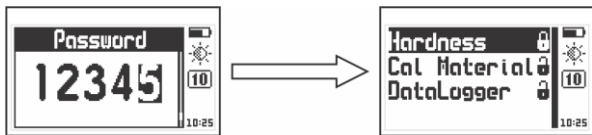

Figure 3.18: Enter password and options lock menu

Each option is followed by a lock indicating whether the feature is locked (closed lock) or unlocked (open lock).

Touch  on each of the following options to lock or unlock:

Configure: Lock or unlock hardness configuration options (material, hardness unit).

Cal Material: Lock or unlock the possibility of creating and or changing user materials (Page 33).

DataLogger: Lock or unlock datalogger configuration options.

3.3.10 Return to factory default settings

Configure » Set Default

Choose Set Default to return to the original factory default general configuration options.

Touch  and a confirmation screen will appear.





Touch  to confirm and return to the previous menu or touch  to exit without making changes.

Figure 3.19: Set factory default settings confirmation screen

3.4 Measuring configuration options Hardness

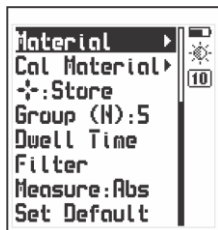

Select **Hardness** from the main menu to display measuring configuration options.

In order to obtain reliable hardness measurements these options must be set correctly.

Figure 3.20: Measuring configuration options menu

3.4.1 Select material Hardness » Material

Touch  on **Material** to select the material that corresponds to the part that will be tested. The QH5 U is calibrated from factory to measure steel and additionally another 8 materials can be generated by the user with samples of a known hardness value as explained in point 3.4.2 below .

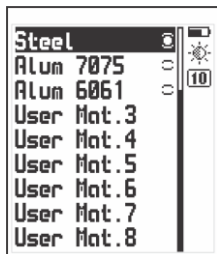

Use the **▲** - **▼** to scroll all menu options and touch **↩** to select.

To exit without changes touch **🏠**.

“Alum 7075” and “Alum 6061” in figure 3.21 are only examples of 2 materials created by the user.

Figure 3.21: Materials menu

For materials that were not created (User Mat. 3 to 8 in figure 3.21) the option to select that material will not appear.

3.4.2 *Creating user materials*

Hardness » Cal Material

The QH5 U can add up to eight (8) materials or alloys. To create a new material the user must have calibration test blocks or samples of a known hardness of the same material that is being created. Touch **↩** on **Cal Material** and the following menu will appear:

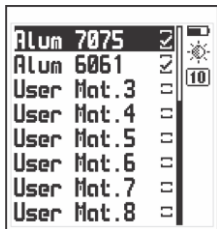

This menu shows the eight user materials, those that have already been defined will appear as selected (“Alum 7075” and “Alum 6061” are examples). Undefined materials will appear unmarked. To edit or create a new user material touch **↩**.

Figure 3.22: User materials menu

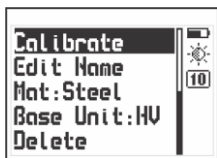

To begin adding a new user material touch  on **Calibrate** and a menu will be displayed with standard base materials needed to create the new user material.

Figure 3.23: New user materials menu



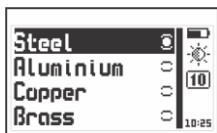

The next step is to choose a base material that is the same (or the closest in case of alloys) to the material of the calibration test blocks or samples and touch . Then touch  to continue.

Figure 3.24: Base material menu



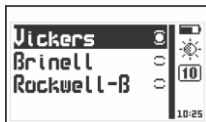

After choosing the base material select the hardness unit that must be the same as that of the calibration test blocks or samples. To select unit touch  and then touch  to continue.

Figure 3.25: Units menu

Hardness unit options will change according to the base material that you selected. Figure 3.25 shows hardness units for aluminum.

After selecting the base material and hardness unit a name can be given to the newly created material. Touch  on **Edit Name** to give the new material a name or simply move on to the next step to keep the default name.

The last and most important step is to enter the hardness values of the calibration test blocks or samples. To begin this process touch

 on **Calibrate**.

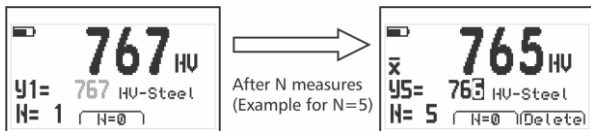



Figure 3.26: First calibration point for the user material

To enter the first calibration point for the new user material make N number of measurements on a calibration test block of a known hardness value. The N number is set in Group (N) (page 39).



The following two options are displayed on the calibration screen:

N=0 : touch the  key to reset the N number of samples in case of erroneous measurements

Erase : touch the  key to erase the last measurement

Single values will be displayed with large numbers and when the N number of measurements is completed the \bar{x} symbol will appear showing the average for the N number of measurements. In the line marked **y1=** the hardness value can be edited so that it matches the value of the calibration test block or sample.

Touch  to accept the first calibration point and two additional options will be displayed as follows:

- **Other** : touch the  to add another calibration point
- **Ready** : touch the  to finalize setup of the new user material with just one calibration point

When a new material is created using one point calibration only displacement for the selected table (base material) is generated. This is known as a grade 0 (zero) equation and could be insufficient to obtain reliable readings. In this case a second test block of the same material but a different hardness value should be used to generate another calibration point.

Select "**Other**" by touching the  to create another calibration point.

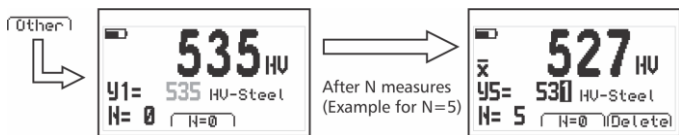

Figure 3.27: Second point for the user material

To enter a second calibration point follow the same steps used to enter the first calibration point.

A new user material can be calibrated with up to 4 different calibration test blocks or samples.

Once the material has been created it will appear on the user materials menu as selected (figure 3.22) meaning that the unit has been calibrated for the new material. The new material will also be displayed in the materials menu.

To erase a user material go to **Delete** in the new user materials menu. Keep in mind that the name is kept unless you change it.

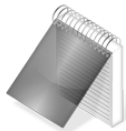

Notes

By default user materials that have not been created are listed as "User Mat. X"

The number of (N) samples used for calibration is set in **Group (N)** (page 39).

User materials can be protected from deletion using lock configuration options (page 31).

3.4.3 *The "Plus" key* Hardness »

In the measuring screen the  is used to quickly access any of the options below as configured by you.

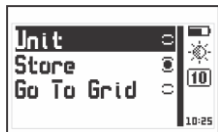



Touch  on  to open and setup quick access options.

Figure 3.28: Quick access options menu for the "Plus" key

Quick access options that can be set for the  key are:

Unit: Use to change the hardness unit

Store: Save measurements manually

Go to grid: Open grid location in file



3.4.4 *Set group (N) number*

Hardness » Group (N)

In order to obtain more reliable measurements with your QH5 U we recommend that you take at least 3 (three) measurements within 3 to 4mm from one another and use the average of all 3 values as your final hardness value.

Set the **(N)** number of measurements that will be used for averages, statistics and in each column of the datalogger.

Every **(N)** number of measurements the unit automatically updates statistics for the group and closes the lot in the datalogger. Partial statistics can also be viewed at anytime touching the  key.

Touch  in **Group (N)** to open the numbers editor and to set the number of measurements. Touch  to save and  to exit.

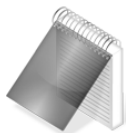

Note

When changing the hardness unit the N number is reset to zero, the lot that was open is closed and new column / lot is automatically opened.

3.4.5 *Indenter dwell time*

Hardness » Dwell Time

Dwell Time allows you to set the time that it takes the unit to display a reading after force has been applied on the probe.

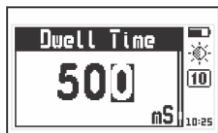

Use the **▲** **▼** keys to set the time (milliseconds) and touch **↩** to save and exit.

Touch **🏠** to exit without changes.

Figure 3.29: Adjust unit Dwell time

3.4.6 *Measuring filter*

Hardness » Filter

This option allows you to set a measuring filter so that noisy or erroneous measurements are discarded. In practice this means that obtaining precise readings takes more time as extra care must be taken when preloading the probe. Force must be applied gently without “hitting” the probe on the part being tested.

When a measurement doesn't meet the filter criteria the unit discards that measurement and a message reading “MEASURE FAILURE!” shows in the unit display.

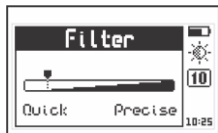

Touch **▲** **▼** to set the filter and touch **↩** to save and exit.

Touch **🏠** to exit without changes.

Figure 3.30: Measuring filter



Important

Keep in mind that setting the filter for more precision means extra care particularly when measuring soft non-ferrous materials or steel under 400HV.

3.4.7 *Select measuring mode* Hardness » Measure

Touch  on **Measure** to open measuring mode options.

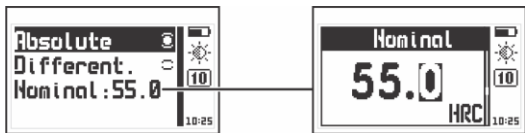

Figure 3.31: Measure mode options and nominal value



The modes in which measurements can be represented are:

Absolute: The unit displays the real measured value.

Differential: The value displayed is a result of the value obtained from calculating:

$$\text{Differential} = \text{Real value} - \text{Nominal value}$$

The nominal value is a reference value for the test piece.

Touch  on **Nominal** to set this value and touch  to save. To exit without making any changes touch .

3.4.8 *Return to factory default settings*

Hardness » Set Default

Choose **Set Default** to return to the original factory default hardness configuration settings.

Touch  and a confirmation screen will appear.





Touch  to confirm and return to the previous menu or touch  to exit without making changes.

Figure 3.33: Set factory default settings confirmation screen

4 Using the Datalogger

4.1 Understanding how data is organized

In order to optimize the use of the Datalogger in your QH5 U you first need to understand how data is organized. Up to 8 individual files with alphanumeric names are used to store data. Each file contains a grid with columns and rows, and each grid contains columns identified with consecutive letters (A, B, ...AA, AB...) that store an N number of measurements (group). Each value is identified with a column letter and a row number.

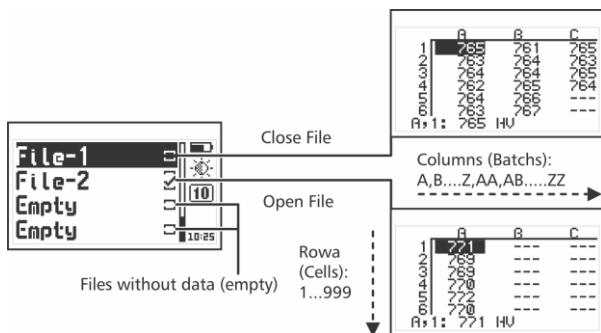

Figure 4.1: Organización de datos

With this grid structure the location of a value is always represented in a "Batch, Cell". For example F,7 means that the value is stored in column / batch F, row / cell 7.

The number of measurements in a batch is set in **Group (N)** so that every time the batch reaches the N number of values it automatically closes and a new batch is opened. When the (N) is changed the number of measurements changes without closing the file which allows different size batches within a single file.

4.2 Memory menu

Memory

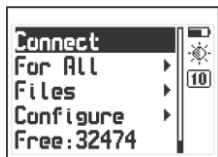

Select **Memory** from the main menu to view all menu options for the Datalogger. This chapter explains how to create, organize and view files

Figure 4.2: Memory menu

4.3 Create a new file

Touch  on **Files** and use the cursor keys to navigate the list of files in the unit.

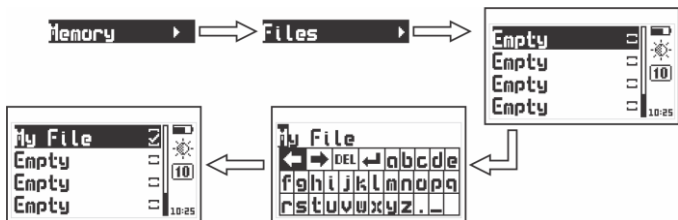



Figure 4.3: Creating a file

Select a file that appears as **Empty** (available file) and touch  to name the file with up to 10 alphanumeric characters.

After you enter a name a checkmark will appear meaning that a new file has been created and is ready to be used. Remember that only one file can be open at any given time so when a new file is created and a file was already open, the open file will be closed. Once a file has been closed, it cannot be reopened and new values can no longer be stored. In closed files, values can only be viewed.

Whenever you create a new file, and another file is already open, a warning screen will ask if you want to close the last file.





Touch  to confirm that you want to close the open file to create (open) a new one or touch  to cancel and return to the menu.

Figure 4.4: Close file confirmation screen

4.4 Actions over single files

Memory » Files » FileName

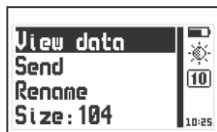

Touch  on any file that is not empty and a menu will open with all of the options of what you can do that file.

Figure 4.5: Individual file menu options

4.4.1 *View data in a single file*

Memory » Files » FileName » View Data

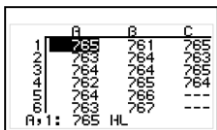

	A	B	C
1	765	761	765
2	763	764	763
3	764	764	765
4	762	765	764
5	764	766	---
6	763	767	---
R, 1:	765	HL	





Touch  on **View Data** to view the contents of the file. Touch  to exit the file.

Figure 4.6: View data in file (grid format)

To move inside the grid use the cursor keys and touch  to jump to the last column containing data.



Touch  on a value to open a histogram that includes that same value as well as the values included in the foregoing cells within that column.





Touch  to exit and return to the grid.

Figure 4.7: Columns histogram

High and low hardness alarms appear in the histogram as dotted horizontal lines.

4.4.2 The “Q” key in a grid

Touch  to open the quick access menu that allows you to go directly to a position inside the grid.

Select the **Row**, **Column**, and **Cell** using the    keys.

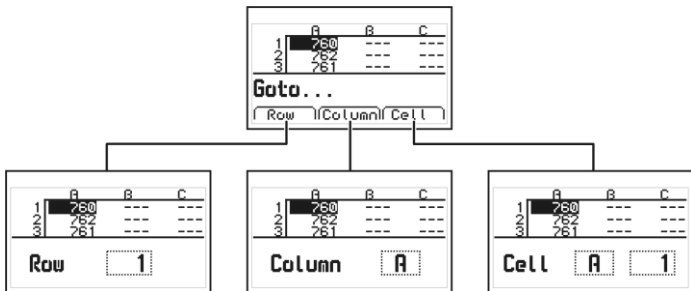





Figure 4.8: Quick access menu options in a grid

Row: Enter a row number using the cursor keys so that when you touch  the grid will position itself directly on that row.

Column: Enter the column letter using the cursor keys so that when you touch  the grid will position itself on that column.

Cell: This is a combination of (column and row) so that you can go to a specific cell after you enter the row number and column letter.

4.4.3 The “Q” in a histogram

Touch  in the histogram to open the quick access menu that allows you to obtain statistical information on the group of values being displayed.

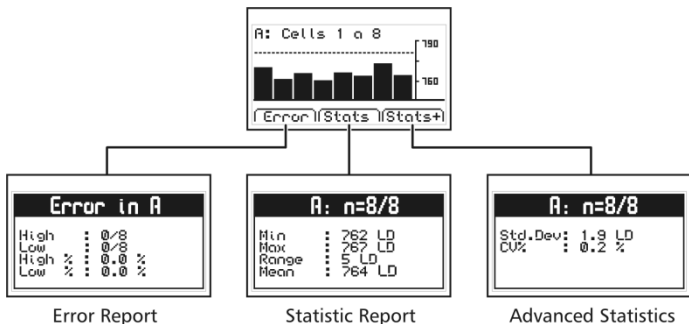

Figure 4.9: Quick access menu options in a histogram

Error: Displays the number of errors and error percentage values in the batch based on the high and low alarm settings.

Stats: View statistical information for the batch including Min., Max., Range and Mean values

Stats+: View the standard deviation and the percentage (coefficient variation) for the batch.

4.4.4 Rename file

Memory » Files » FileName » Rename

Touch  on **Rename** to open the text editor that allows you to change the file name.

4.4.5 *Send data in file*

Memory » Files » FileName » Send

Touch  on **Send** to send (units with Datalogger only) a single file to a PC using Windows HyperTerminal, or to a printer using an RS232 connection. This option does not work in USB mode.

4.4.6 *View file size*

Memory » Files » FileName » Size

Touch  on **Size** to view the number of stored values within a single file (and the size of the file as a percentage of total unit memory). You can also view the date and time in which the file was created.

4.5 *Actions on all files*

Memory » For All





Touch  on **For all** to open the menu for actions that will affect all files stored in the unit memory.

Figure 4.10: Actions on all files menu

4.5.1 *Send all files*

Memory » For All » Send All

Touch  on **Send All** to send (units with Datalogger only) all files stored in the unit memory to a PC using Windows HyperTerminal, or to a printer using an RS232 connection. This option does not work in USB mode.

4.5.2 Erase all files Memory » For All » Erase All

The **Erase All** action permanently deletes all files stored in the unit memory and recovers 100% of the memory capacity.

Before files are deleted, a screen will be displayed asking you to confirm or to cancel this action.

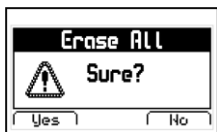

Touch **>** to cancel and return to the previous menu or touch **<** to begin deleting all files.

Figure 4.11: Erase all confirmation screen

When the erase all action has been confirmed the following screens will be displayed:

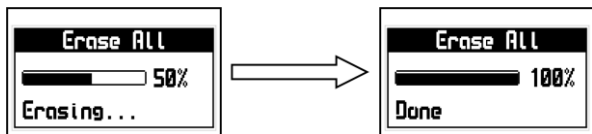

Figure 4.12: Erase all progress screen

After the memory is erased all files will be shown with the name **Empty** and in the measuring screen the datalogger will appear with **No File**.

4.6 Quick memory menu (Mem key)

Touch **V** on the measuring screen to open the quick memory menu.



Figure 4.13: Quick memory menu options

In each quick memory menu screen three options are displayed. To access these options use the **<**, **^**, **>** keys. To change memory screens use the **V** key as seen on figure 4.13.

Options in the first quick access memory screen:

Label: Allows you to tag a value with a number from 0 to 65000 so that it can be easily identified in the grids viewed with DataCenter. Tags are not seen in the grids displayed in the unit.

Close: Close the current file and opens a new one.

Delete: Delete the last stored value.

Options in the second quick access memory screen:

Time: Inserts the time when the value was stored.

Auto: Activates the auto capture mode.

Manu: Activates the manual capture mode.

4.7 Connecting to a PC with DataCenter Memory » Connect

Touch  on **Connect** to enter "Connect Waiting: USB" mode.

Touch  to exit and cancel the connection.



Figure 4.14: Connecting to a PC

With the unit waiting to connect plug the USB cable first to the QH5 U and then to the PC, open dmq DataCenter software and click <Connect> in DataCenter.

When a successful connection is established the files in your unit memory will appear in DataCenter. To view their contents simply double click on each file.

For additional information on dmq DataCenter software refer to the manual included in the dmq pendrive that you received with your QH5 U unit or download the manual at:

<http://www.demeq.com/Download.html>

4.8 Datalogger configuration

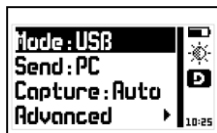

In the memory menu touch  on **Configure** to open the Datalogger configuration options menu.

Figure 4.15: Datalogger configuration menu

4.8.1 *Configure communications*

Memory » Configure

The first two options in the configure Datalogger menu are **Mode** and **Send** which allow you to select how the unit will communicate with a PC (USB or RS232) and if you will be sending data to a PC or an external printer.

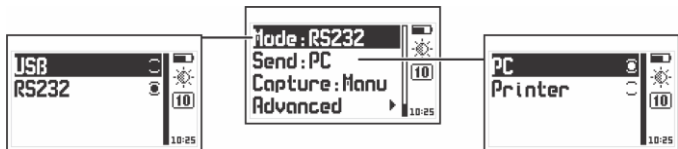



Figure 4.16: Configure communications options

Touch  on Mode to select the type of connection.

USB: Select USB to connect to a PC using a USB cable (included).

RS232: Select RS232 to connect to a PC or printer using an RS232 cable (optional).

Touch  on Send to select whether you will send files to a PC or a printer.

PC: When using an RS232 cable the unit sends data in an optimal format for Windows HyperTerminal (38400-8-N-1).

Printer: Using an RS232 cable and printer the unit sends data in an optimal format for mini-printers of 40 columns (9600/8-N-1).



Notes

The printer option can only be used in RS232. Files cannot be directly sent to a USB printer.

When you use DataCenter to connect your selection of PC or print will not affect communication.

4.8.2 *Capture modes*

Memory » Configure » Capture





Touch  on **Capture** to select the mode in which values will be stored in the Datalogger.

Figure 4.17: Memory capture options

The QH5 U has two modes in which to store values

Manual: Touch the  key to store values.

Auto: Each time a measurement is made it is automatically stored in the Datalogger, when this option is selected you can also store values touching the  key.

4.8.3 *Advanced configuration*

Memory » Configure » Advanced











Touch  on **Advanced** to access the advanced configuration options menu for the Datalogger.

Figure 4.18: Advanced configuration options

When you enable **History** the Datalogger will register the unit settings for each measurement that is stored (this information can only be viewed in DataCenter). When history is enabled the unit memory capacity decreases as more data is stored.

Touch  on **History** to enable or disable this option and touch  to exit.

Touch  on **Clock** to set the time and date options that will be recorded by the Datalogger each time a new batch is opened. Touch  -  to scroll all menu options and touch  to select and exit. Touch  to exit without making changes.

Clock menu options include:

Off: The Datalogger does not record date and time.

Date: When a new batch is opened the Datalogger records the date.

Time: When a new batch is opened the Datalogger records the time.

Both: When a new batch is opened the Datalogger records the date and time.

Tips on how to measure correctly

Choose the UCI probe that is best suited for your application and take all of the following into consideration.

Measuring ranges and hardness units

Unit	Material			
	Steel	Aluminum	Copper	Brass
HV	100~940	44~189	40~130	45~196
HB	95~500	40~160	75~120	42~169
HRB	55~100	28~91	2~67	10~93
HRC	20~68	—	—	—
HS	32~97	—	—	—
MPa	320~2190	—	—	—

The following are minimum test piece requirements that need to be met in order to obtain precise and repetitive measurements.

	QHUS10 (10N / 1kgf)	QHUS50 (50N / 5kgf)
Roughness (Ra)	1,5 μm	2,5 μm
Curvatura Radio	>5 mm	
Weight	>0,1 Kg	
Thickness	<1 mm	

Recommendations for better results

Don't measure of a previous indentation or in highly corroded parts.

The test piece surface must be clean, dry and free of grease.

To obtain best results you should always take an average of at least 3 measurements.

Do not apply force on the UCI probe right after connecting the probe to the unit as this may cause the internal calibration to fail.

Always make sure to configure the unit to the material being tested.

Do not use lubricants or grease in the mechanical parts of the probe.

Technical Specifications

Measuring principle	UCI (Ultrasonic Contact Impedance)
UCI probes	QHSU10 (10N) / QHSU50 (50N)
Base materials	Steel, aluminum, copper, brass
Units	Vickers, Brinell, Rockwell B / C, Shore, MPa
Resolution (complete range)	Vickers : 1 HV Brinell : 1 HB Rockwell : 0,1 HRB / C Shore : 0,1 HS MPa: 1 MPa
Measuring range	Depends on hardness unit and material. See table on page 55.
Precision	In Vickers: $\pm 5\%$
Conversions	According to ASTM E 140 and DIN 50150
Realtime statistics	Maximum, Minimum, Average, Range and Standard Deviation
Alarms	Minimum and maximum. Audible and visible.
Languages	English, Spanish, Portuguese
Datalogger	Up to 32500 values with 8 files. Manual & automatic capture modes. Alphanumeric file names. Date and time register. View grid and graphic data statistical calculations.

PC connection	USB and RS232
LCD display	Graphic 128 x 64 pixels with adjustable contrast and backlight. 24 mm tall digits.
Keypad	Touch sense keypad with no mechanical parts.
Battery life	100 Hs with type "AA" alkaline batteries.
Operating Temperature	-10°C to +50°C
Dimensions	78 x 117 x 24 mm
Weight	200 gr with batteries

Additional information

To become a part of the Demeq family of users and to receive newsletters as well as promotional offers that are available only to dmq customers please register online at:

http://www.demeq.com/form_Register.html

Unit maintenance

The QH5 U was developed and manufactured for years of trouble free operation and even though the unit does not require special care the following precautions should be considered:

- Avoid contact with corrosive and abrasive substances.
- Do not clean the unit with solvents.
- Do not leave the unit display exposed to direct sunlight for prolonged periods of time as this could damage the display.
- Remove the batteries if the unit will be stored for an extended period of time.
- Remove the probe by pulling from the connector at the end of the cable and not from the cable.
- Do not twist or strangle the probe cable.
- Do not expose the unit to temperatures below -10°C / 14°F or above 50°C / 122°F.

QH5 U accessories

Part No.	Description
QHS010	UCI probe 10 N
QHS050	UCI probe 50 N
QHG005	Coupling paste
QHP001	Silicone protective cover (electronic unit)
QAC001	Thermal printer USB connecting cable
QAI001	Thermal printer
Test Blocks	Inquire on HV, HB, HRB, HRC test blocks available in steel as well as in other materials

For more information on accessories available for your QH5 U please contact Demeq at infodemeq@demeq.com

Error Messages

Under abnormal conditions an error messages may appear be displayed on the unit screen and should be treated as informational only.

If an error message is displayed follow the instructions described below and if the problem persists please send us a detailed report at: http://www.demeq.com/form_Support.html



Figure A.2: System error message

Error 1	Internal Error
Cause	Internal Error
Solutions	Turn off the unit and power back on. If the problem persists contact Demeq.

Error 2	Attempt to overwrite a value.
Cause	This error can happen when the unit is turned off correctly (removing batteries) and when the unit is turned back on you try to save value in the datalogger.
Solution	Download the existing values in the datalogger to a PC and erase the memory.

If a message appears with a different number contact Demeq.

Our website: www.demeq.com

Our website is a powerful customer support tool where you will find the latest information as it relates to your QH5 U including:

- Manuals and brochures
- Firmware and software updates
- New accessories

Firmware and software updates

To download firmware and software updates to your QH5 U you must have dmq DataCenter installed on your PC. To download the latest updates visit:

<http://www.demeq.com/Download.html>

Technical support

Our service department is committed to providing prompt and courteous service. Should you encounter any trouble with your QH5 U please send us a detailed description of your problem to:

http://www.demeq.com/form_Support.html

